



Frame

Designed by Justin Hutchinson
for Kett
2022

Exclusive to Cosh Living
coshliving.com.au

Bedroom

The Frame Bedroom collection integrates storage and technology into a seamless furniture solution for the home.

Frame allows a personalised solution to furniture and joinery needs by offering a wide range of functions and finishes to complement the bedroom.

Frame is the outcome of our research into innovative connection systems that afford an exact and robust method of installation for many interior walls, from plasterboard through to masonry.

Sustainability and health are key considerations in the development of Frame, with materials free of formaldehyde, phenols, solvents, PVC or melamine.

Frame defines the room by allowing the surrounding walls to express the space, making Frame much lighter than traditional wall-to-wall joinery.

Designed & Made in Australia

6 Panel A

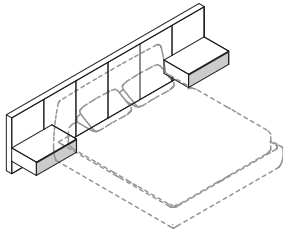

360

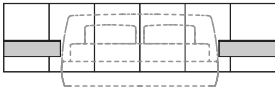

FB-90-6P-A

6 Panel B

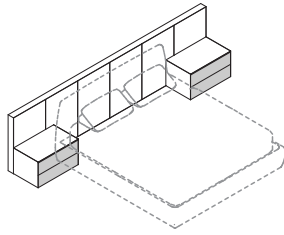

360

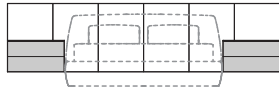

FB-90-6P-B

6 Panel C Left

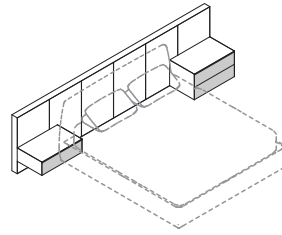

360

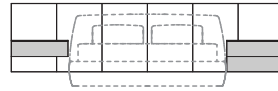

FB-90-6P-C-L

6 Panel C Right

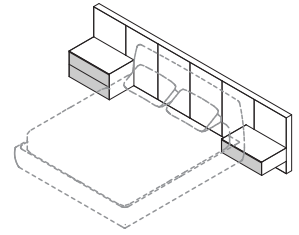

360

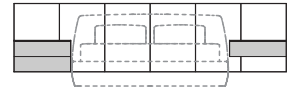

FB-90-6P-C-R

7 Panel A Left

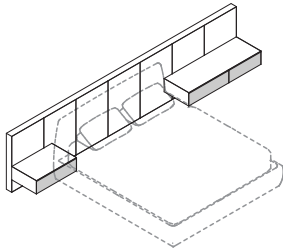

420



FB-90-7P-A-L

7 Panel A Right

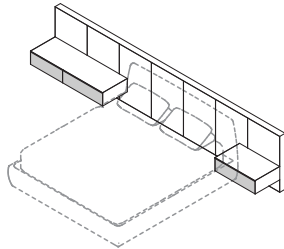

420



FB-90-7P-A-R

7 Panel B Left

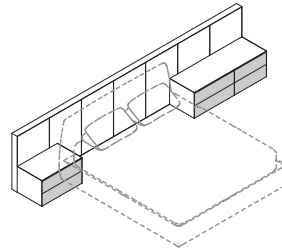

420

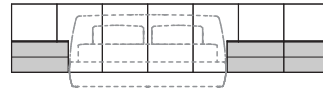

FB-90-7P-B-L

7 Panel B Right

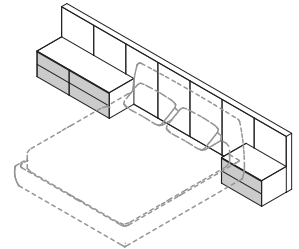

420

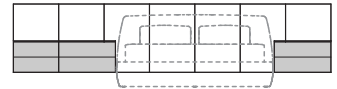

FB-90-7P-B-R

7 Panel C Left

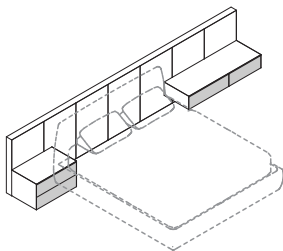

420

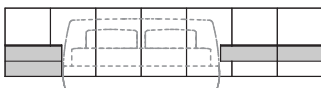

FB-90-7P-C-L

7 Panel C Right

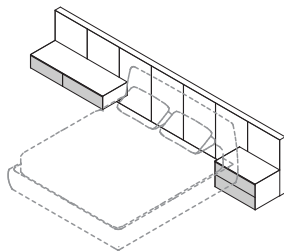

420

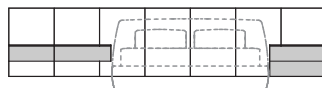

FB-90-7P-C-R

7 Panel D Left

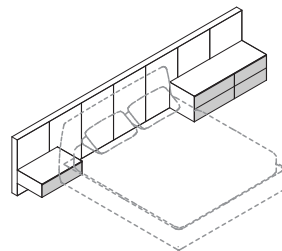

420

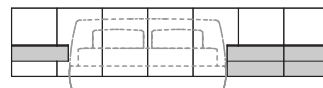

FB-90-7P-D-L

7 Panel D Right

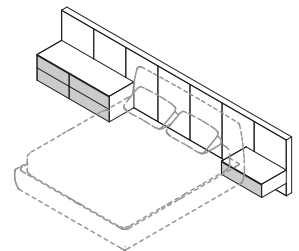

420

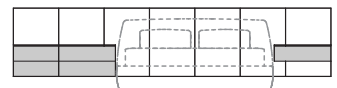

FB-90-7P-D-R

8 Panel A

8 Panel B

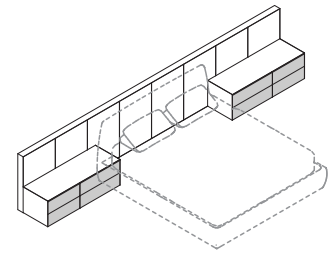
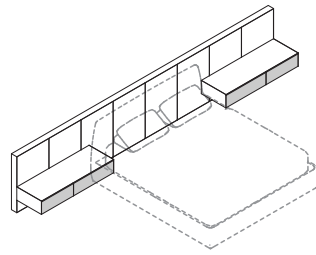

480

480

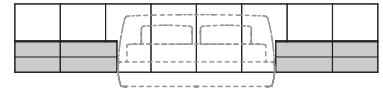
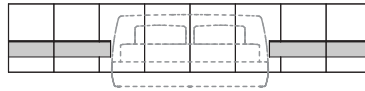

FB-90-8P-A

FB-90-8P-B

8 Panel C Left

8 Panel C Right

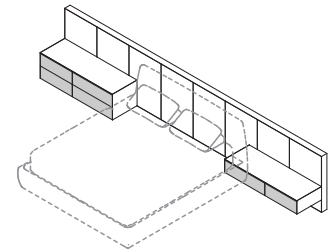
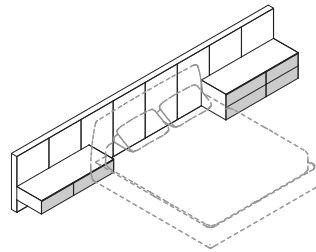





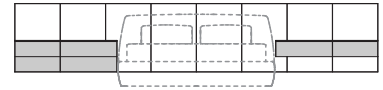
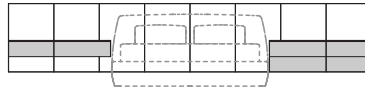



480

480

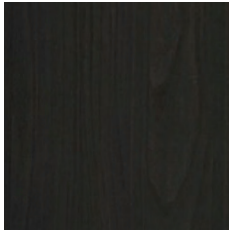

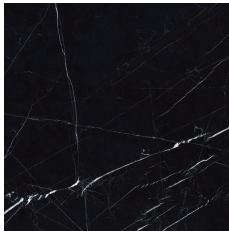
FB-90-8P-C-L

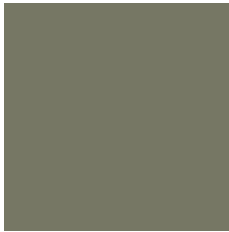
FB-90-8P-C-R

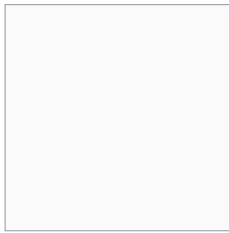
	Natural Oak	Lt Walnut	Charcoal Oak	Exhibition
				
Porcelain	Calacatta Oro Venato	Bianco Statuario Venato	Marquinia	
				
Powder Coat	City (Red)	Mangrove (Green)	Ocean (Blue)	
				
		Black	White	
				

Guide Only

This is an indicative guide only. Please refer to physical Kett samples for a more accurate representation of actual finishes.

Technical

Discover Kett at kettfurniture.com.au

Exclusive to Cosh Living coshliving.com.au

Materials

Powder coated metal frame; wall panels, cabinets and drawer fronts are constructed of a cellulose fibre face and an E0 MRMDF substrate.

Porcelain Surface

Calacatta Oro Venato (Soft Touch)
Bianco Statuario Venato (Soft Touch)
Marquinia

Timber Finishes

Natural Oak
Lt Walnut
Charcoal Oak
Exhibition

Powder Coat

Mangrove (Green)
Ocean (Blue)
City (Red)
Black
White

E.g. Supply the following per module

Rear Panels - Charcoal Oak
Door Fronts - Lt Walnut
Porcelain Surface - Marquinia
Powder Coat - City (Red)

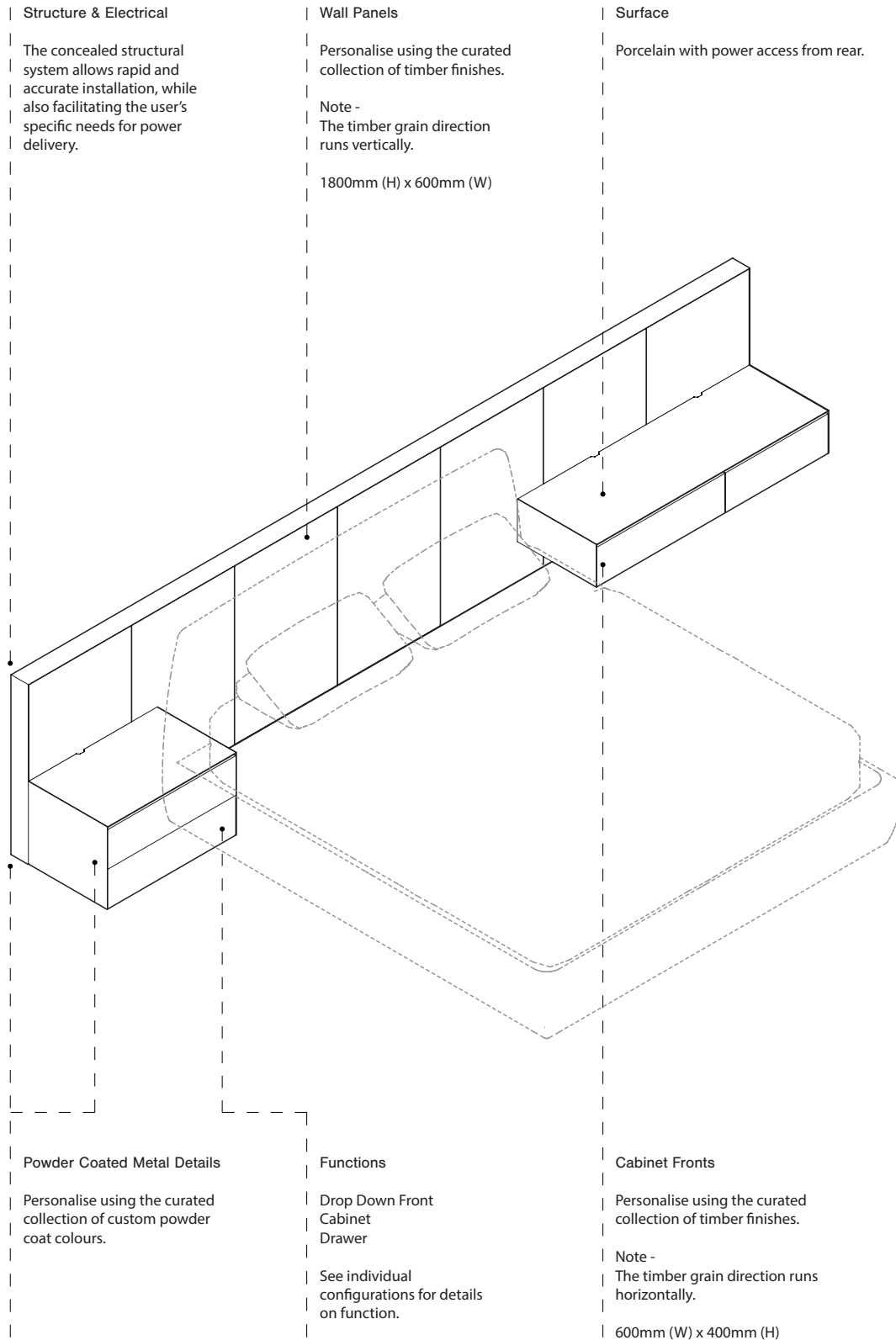

Erskine Bed (Queen)

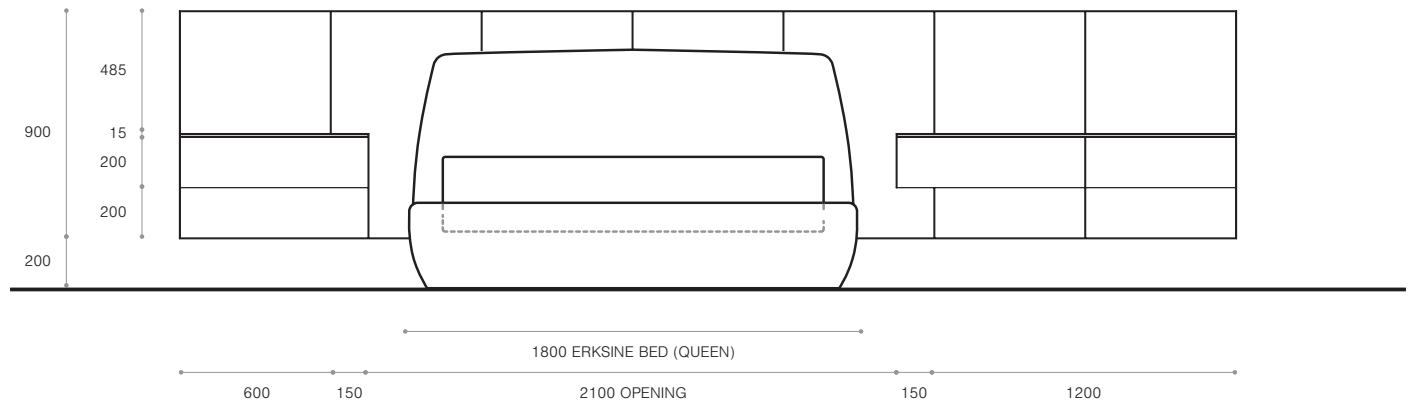

Erskine Bed (King)

